

## NPN Silicon AF Transistors

**SMBTA 05**  
**SMBTA 06**

- High breakdown voltage
- Low collector-emitter saturation voltage
- Complementary types: SMBTA 55  
SMBTA 56 (PNP)

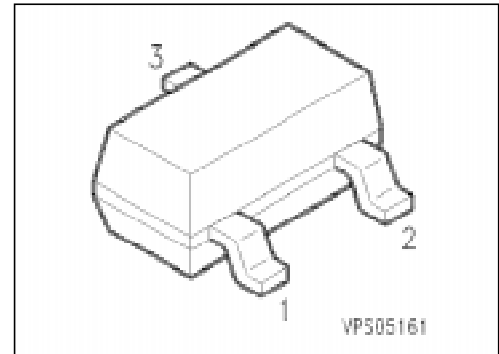

Type	Marking	Ordering Code (tape and reel)	Pin Configuration			Package <sup>1)</sup>
			1	2	3	
SMBTA 05	s1H	Q68000-A3430	B	E	C	SOT-23
SMBTA 06	s1G	Q68000-A3428				

### Maximum Ratings

Parameter	Symbol	Values		Unit
		SMBTA 05	SMBTA 06	
Collector-emitter voltage	$V_{CE0}$	60	80	V
Collector-base voltage	$V_{CB0}$	60	80	
Emitter-base voltage	$V_{EB0}$	4		
Collector current	$I_C$	500		mA
Peak collector current	$I_{CM}$	1		A
Base current	$I_B$	100		mA
Peak base current	$I_{BM}$	200		
Total power dissipation, $T_s = 79\text{ °C}$	$P_{tot}$	330		mW
Junction temperature	$T_j$	150		°C
Storage temperature range	$T_{stg}$	- 65 ... + 150		

### Thermal Resistance

Junction - ambient <sup>2)</sup>	$R_{th\ JA}$	≤ 285	K/W
Junction - soldering point	$R_{th\ JS}$	≤ 215	

1) For detailed information see chapter Package Outlines.

2) Package mounted on epoxy pcb 40 mm × 40 mm × 1.5 mm/6 cm<sup>2</sup> Cu.

## Electrical Characteristics

at  $T_A = 25\text{ °C}$ , unless otherwise specified.

Parameter	Symbol	Values			Unit
		min.	typ.	max.	

### DC characteristics

Collector-emitter breakdown voltage $I_C = 1\text{ mA}$	$V_{(BR)CE0}$	60 80	— —	— —	V
SMBTA 05 SMBTA 06					
Collector-base breakdown voltage $I_C = 100\text{ }\mu\text{A}$	$V_{(BR)CB0}$	60 80	— —	— —	
SMBTA 05 SMBTA 06					
Emitter-base breakdown voltage $I_E = 10\text{ }\mu\text{A}$	$V_{(BR)EB0}$	4	—	—	
Collector-base cutoff current $V_{CB} = 60\text{ V}$ $V_{CB} = 80\text{ V}$ $V_{CB} = 60\text{ V}, T_A = 150\text{ °C}$ $V_{CB} = 80\text{ V}, T_A = 150\text{ °C}$	$I_{CB0}$	— — — —	— — — —	100 100 20 20	nA nA $\mu\text{A}$ $\mu\text{A}$
SMBTA 05 SMBTA 06 SMBTA 05 SMBTA 06					
Collector cutoff current $V_{CE} = 60\text{ V}$	$I_{CE0}$	—	—	100	nA
DC current gain <sup>1)</sup> $I_C = 10\text{ mA}, V_{CE} = 1\text{ V}$ $I_C = 100\text{ mA}, V_{CE} = 1\text{ V}$	$h_{FE}$	100 100	— 130	— 170	—
Collector-emitter saturation voltage <sup>1)</sup> $I_C = 100\text{ mA}, I_B = 10\text{ mA}$	$V_{CEsat}$	—	—	0.25	V
Base-emitter saturation voltage <sup>1)</sup> $I_C = 100\text{ mA}, V_{CE} = 1\text{ V}$	$V_{BE}$	—	—	1.2	

### AC characteristics

Transition frequency $I_C = 20\text{ mA}, V_{CE} = 5\text{ V}, f = 20\text{ MHz}$	$f_t$	—	100	—	MHz
Output capacitance $V_{CB} = 10\text{ V}, f = 1\text{ MHz}$	$C_{obo}$	—	12	—	pF

<sup>1)</sup> Pulse test conditions:  $t \leq 300\text{ }\mu\text{s}$ ,  $D = 2\%$ .

### Total power dissipation $P_{tot} = f(T_A^*; T_S)$

\* Package mounted on epoxy

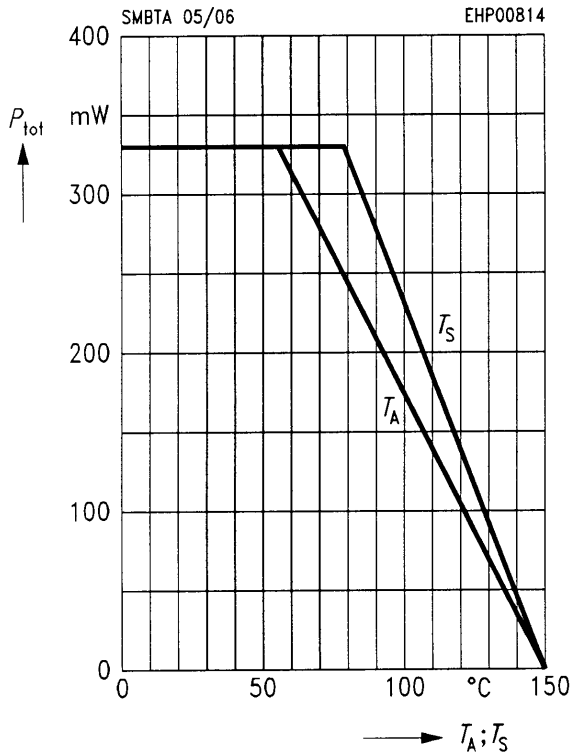

### Collector current $I_C = f(V_{BE})$

$V_{CE} = 1$  V

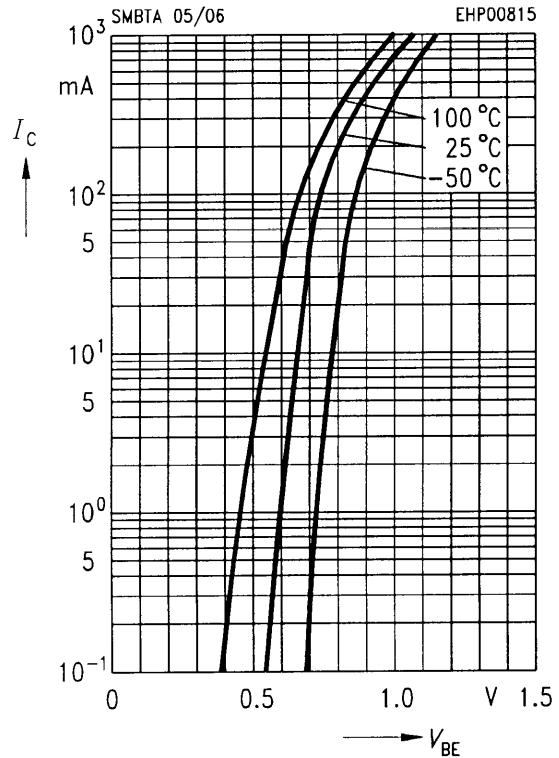

### Permissible pulse load $P_{tot max}/P_{tot DC} = f(t_p)$

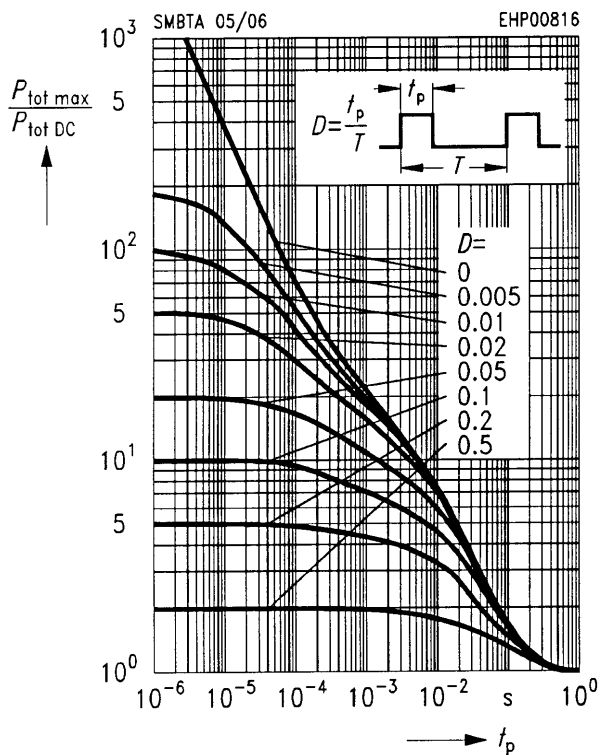

### Transition frequency $f_T = f(I_C)$

$V_{CE} = 5$  V

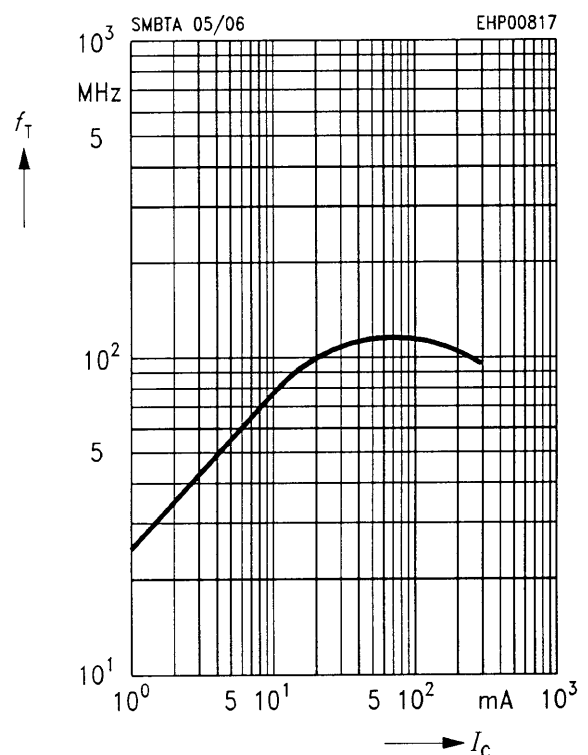

**Base-emitter saturation voltage**

$I_C = f(V_{BEsat}), h_{FE} = 10$

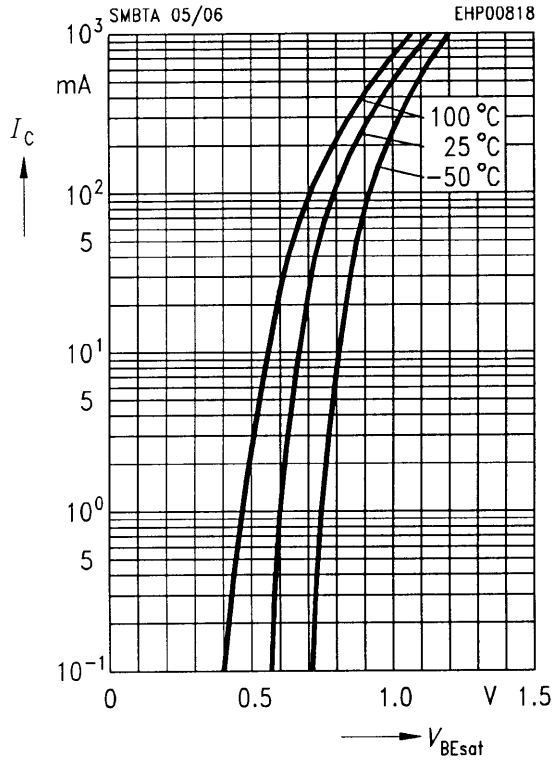

**Collector-emitter saturation voltage**

$I_C = f(V_{CEsat}), h_{FE} = 10$

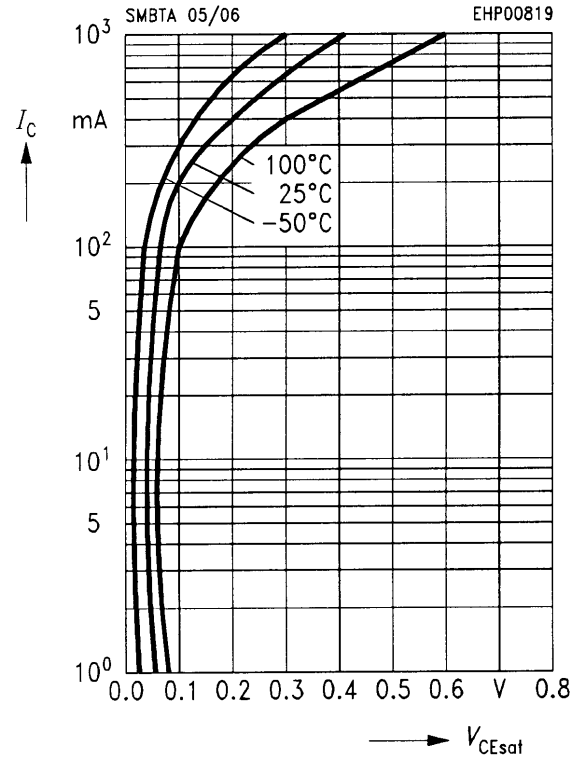

**Collector cutoff current  $I_{CB0} = f(T_A)$**

$V_{CB} = V_{CEmax}$

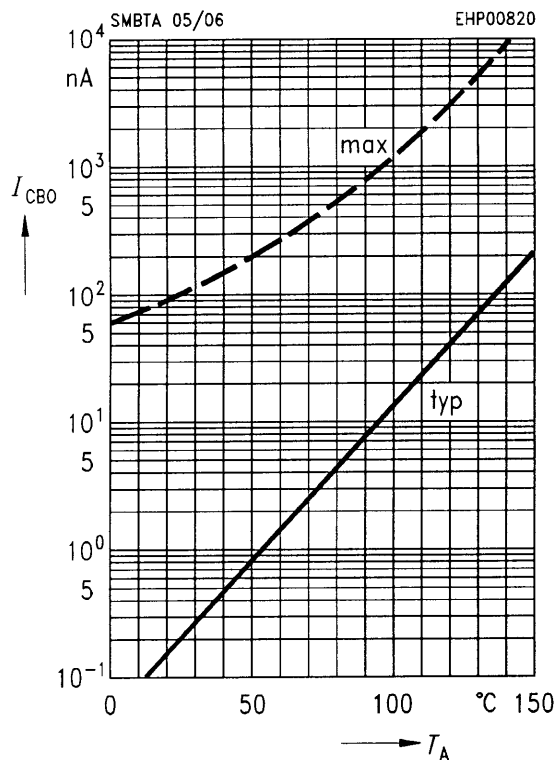

**DC current gain  $h_{FE} = f(I_C)$**

$V_{CE} = 1 V$

